

# Installation instruction

## Bluetooth hands free kit

### FISCON

#### „Basic-Plus“

article-ID 36496 / 36496-1

head unit	VW RNS 510
head unit	VW RCD 510
head unit	Skoda Columbus
head unit	Seat with Touchscreen

#### „Basic“

article-ID 36495 / 36495-1

for all factory fitted VW, Skoda, Seat head units

#### Volkswagen

Golf 5, Jetta (1K0)  
Golf 6 (1K9), from SW-Index 1.62  
Touran (1T0)  
Tiguan (5N0)  
EOS (1F)  
Passat 3C (3C0)  
Passat CC (3C8), from SW-Index 1.62  
Caddy (2K)  
Scirocco (1K8)  
Touareg (7L) GP from 2008, from SW-Index 1.63  
T5 (7E) 2010, from SW-Index 1.85

#### Skoda

Oktavia II (1Z)  
Skoda SuperB (3T), from SW-Index 1.62  
Skoda Yeti, from SW-Index 1.62

#### Seat

Leon (1P), from SW-Index 1.62

## Content

FISCON	01
Safety Instructions	02
Installation instruction	03
Coding VAS	04
Coding VAG-COM (VCDS)	05
Control elements	04
FISCON operation menu	05
FISCON setup through mobile phone	06
Operating instruction	07
Interface - Diagnostic	13
FAQ	14

---

## Bluetooth Hands free kit

- Controlled by Navigation unit VW RNS 510, RCD 510, Skoda Columbus (only for Basic-Plus version).
- Controlled by multifunctional steering wheel - MFSW (if available).
- Controlled by wiper control stalk (if available).
- **Direct dial** of telephone numbers
- **DTMF** Dual-tone multi-frequency
- **A2DP Audiostreaming** in order to transfer music to the Infotainment system of the vehicle (depends on mobile phone).
- **SMS** - short messages (depends on mobile phone):
  - SMS reading, sending of ready made sms
- Numerous Setup possibilities:
  - **Microphone adjustment** in order to optimize the voice quality
  - **Volume control** regarding A2DP, Conversation, Ring tone ...
  - Setting of national **language**
- **Unlimited Software Updates**
- Use of the following telephone **operations**:
  - Access to the **phonebook** (depends on mobile phone, display through the cluster)
  - Placing, answering as well as ending calls
  - Volume control
  - SMS
- **E-MFA Add on (Only for vehicles with red DIS)** - DIS extensional display of the following vehicle information:
  - Boost pressure in bar (depends on vehicle)
  - Oil temperature in°C/ F
  - Water temperature in°C/ F
  - Remaining petrol capacity in l
  - Speed in km/h - m/h
  - Revolutions per minute
  - Battery voltage in V
- Easy installation, No cutting of wires necessary

## Scope of delivery

- Bluetooth interface
- Wiring
- Microphone

**NOTE:** Regarding to the country of destination the FISCON interface will support different types of languages (from FISCON software index 1.46).

## Coding

After installation you need to code the system to telephone. Please contact an Audi VW dealer or workshop with diagnostic system.

**Address 19 (CAN Gateway)      —>      Set telephone function from „not coded“ to „coded“**

## safety Instructions

Congratulations to your new Hands free kit.  
Thank you for choosing a product of Kufatec GmbH.

Please take note that the installation can only be done by vehicles which are using a 12V battery. In particular trucks, all-terrain vehicles and commercial diesel cars including taxis are running often with 24V batteries and an installation is not possible in these kind of vehicles.

Before starting the installation the battery of the vehicle has to be disconnected!

Take care to ensure no devices are affected or damaged that are relevant to security or safe operation of the vehicle.

This unit is only for use in the following vehicles. Only connections described within this instruction guide are allowed or required to use for installation.

For damage impact caused by faulty installation, unsuitable connections in appropriate vehicles Kufatec GmbH assumes no liability.

We advise you that these units process data out of the CAN - protocol from the vehicle. As the supplier of this device we don't know the overall system you are working with. If our device causes damage due to other changes made by to the vehicle Kufatec GmbH assumes no liability.

If the car manufacturer's don't agree with the installation of our device by reason of warranty the Kufatec GmbH assumes no liability. Please check conditions and warranty before you begin the installation.

Kufatec GmbH supplier reserves the right to change the device specifications without notice.

**NOTE:** The road traffic has to have your full attention.  
Telephone operations should only be done by suitable traffic and weather situations.  
The volume need to be set that you are still able to realise acoustic warn signals (Police, fire brigade).

**NOTE:** Before installing the FISCON system you need to check whether the car is retrofitted with a video interface not developed by Kufatec GmbH. In case a non-Kufatec video interface is fitted we are not able to guaranty the absolute operation of the FISCON system. You may need to remove the non-Kufatec video interface.

In order to achieve a proper communication you need to keep installation sequence as follows:

**Vehicle** → **FISCON** → **Multimedia (Kufatec Multimedia , TV in motion)**  
**Adapter**

FISCON system can be used in combination with the **Kufatec Multimedia Adapter (from SW 2.53)**.

**NOTE** for **factory fitted** hands free systems (rSAP Premium, UHV):

While using item **36495, 36496:**

- Remove original telephone interface, remove **fuse** of the hands free

While using item **36495-1, 36496-1:**

- Remove original telephone interface - FISCON hands free has to be connected to the original telephone connector

## Installation instruction

Remove the head unit using suitable tools (Fig. 1, 2). With a p&p connection you will complete the fitting.



Fig. 1



Fig. 2

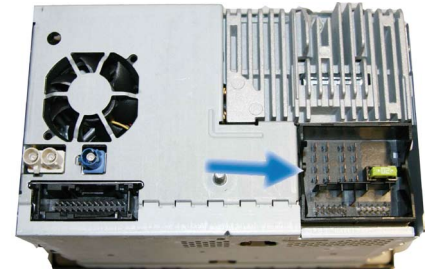

Fig. 3

## Installation instruction for vehicles with factory fitted hands free kit

The location of the original telephone interface can be different within the vehicle.

Move the passenger seat to the far back end. Loosen the necessary screws in order to angle the seat (Fig. 4). Disconnect the original telephone interface (Fig. 5). Connect the delivered loom with original telephone connector coming from the vehicle (Fig. 6).



Fig. 4

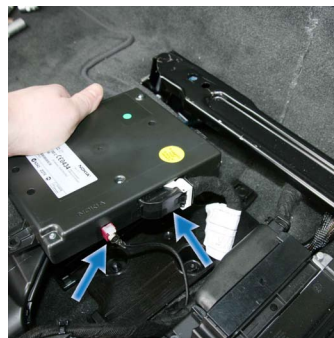

Fig. 5



Fig. 6

NOTE: For VW T5 (Facelift) from 2010 model year the telephone interface is factory fitted behind the glove box.

## Microphone

The connector for the microphone has to be wired along the A-column towards the sun shield.

**ATTENTION:** Does the vehicle have airbags fitted along the A-column it is essential to wire the loom for the microphone **BEHIND** the airbag. Wire the loom without putting tension on it.

For Version(Fig. 8) - Article-ID 36495-1, 36496-1, 36338-2 the original mic has to be replaced.



Fig. 7

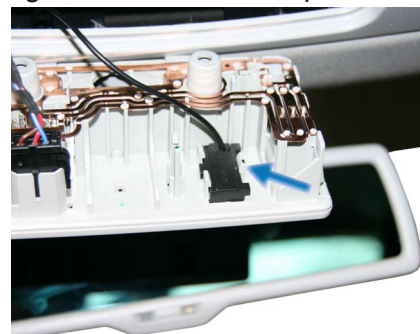

Fig. 8

## Coding VAS

After installation you need to code the system to telephone. Please contact an Audi VW dealer or workshop with diagnostic system.

### Adresse 77

<b>Fahrzeug-Eigendiagnose</b>	
<b>Systemauswahl</b>	
Wählen Sie ein System:	
Eigendiagnose	←
Eigendiagnose - Verbundsysteme	
LT2 Eigendiagnose	
Crafter Eigendiagnose	
<div style="text-align: right;"> <span>◀</span> <span>▶</span> <span>▶▶</span> </div>	

Vehicle Self Diagnostic



<b>Fahrzeug-Eigendiagnose</b>	
<b>Fahrzeugsystem auswählen</b>	
55 - Leuchtweitenregulierung 5C - Spurassistent 16 - Lenkradelektronik 46 - Zentralmodul Komfortsystem 56 - Radio 10 - Einparkhilfe II 07 - Anzeige-/ Bedieneinheit 17 - Schalttafeleinsatz 37 - Navigation 47 - Soundsystem 77 - Telefon 0E - Mediaplayer Position 1 08 - Klima-/Heizungselektronik 19 - Diagnoseinterface für Datenbus ←	
<div style="text-align: right;"> <span>◀</span> <span>▶</span> <span>▶▶</span> </div>	

Address 19 CAN Gateway



<b>Fahrzeug-Eigendiagnose</b>	19 - Diagnoseinterface für Datenbus
<b>Unterstützte Funktionen</b>	Interfacebox
<b>Diagnosefunktion auswählen</b>	Codierung 1
	Betriebsnummer
001 - Identifikation (Dienst \$1A) 004 - Fehlerspeicherinhalt 008 - Codierung (Dienst \$) ← 011 - Messwerte 014 - Lange Anpassung 015 - Zugriffsberechtigung 017 - Sicherheit 022 - Ausgabe beenden Alle Diagnosefunktionen anzeigen	
<div style="text-align: right;"> <span>◀</span> <span>▶</span> <span>▶▶</span> </div>	

008 Coding



<b>Fahrzeug-Eigendiagnose</b>	19 - Diagnoseinterface für Datenbus
<b>Unterstützte Funktionen</b>	Interfacebox
<b>Diagnosefunktion auswählen</b>	Codierung 1
	Betriebsnummer
008.01 - Codierung 008.02 - Codierung Verbauliste ←	
<div style="text-align: right;"> <span>◀</span> <span>▶</span> <span>▶▶</span> </div>	

Component list



<b>Fahrzeug-Eigendiagnose</b>	19 - Diagnoseinterface für Datenbus																						
<b>Unterstützte Funktionen</b>	Interfacebox																						
<b>Diagnosefunktion auswählen</b>	Codierung 1																						
	Betriebsnummer																						
<table border="0"> <tr> <td>10 - Einparkhilfe II</td> <td>codiert</td> </tr> <tr> <td>20 - Fernlichtassistent</td> <td>nicht codiert</td> </tr> <tr> <td>30 - Sonderfunktion</td> <td>nicht codiert</td> </tr> <tr> <td>07 - Anzeige-/Bedieneinheit</td> <td>codiert</td> </tr> <tr> <td>17 - Schalttafeleinsatz</td> <td>codiert</td> </tr> <tr> <td>37 - Navigation</td> <td>codiert</td> </tr> <tr> <td>47 - Soundsystem</td> <td>codiert</td> </tr> <tr> <td>57 - TV-Tuner</td> <td>nicht codiert</td> </tr> <tr> <td>67 - Sprachsteuerung</td> <td>nicht codiert</td> </tr> <tr> <td>77 - Telefon</td> <td>codiert ←</td> </tr> <tr> <td>6C - Rückfahrkamera</td> <td>codiert</td> </tr> </table>		10 - Einparkhilfe II	codiert	20 - Fernlichtassistent	nicht codiert	30 - Sonderfunktion	nicht codiert	07 - Anzeige-/Bedieneinheit	codiert	17 - Schalttafeleinsatz	codiert	37 - Navigation	codiert	47 - Soundsystem	codiert	57 - TV-Tuner	nicht codiert	67 - Sprachsteuerung	nicht codiert	77 - Telefon	codiert ←	6C - Rückfahrkamera	codiert
10 - Einparkhilfe II	codiert																						
20 - Fernlichtassistent	nicht codiert																						
30 - Sonderfunktion	nicht codiert																						
07 - Anzeige-/Bedieneinheit	codiert																						
17 - Schalttafeleinsatz	codiert																						
37 - Navigation	codiert																						
47 - Soundsystem	codiert																						
57 - TV-Tuner	nicht codiert																						
67 - Sprachsteuerung	nicht codiert																						
77 - Telefon	codiert ←																						
6C - Rückfahrkamera	codiert																						
<div style="text-align: right;"> <span>◀</span> <span>▶</span> <span>▶▶</span> </div>																							

Telephone from „not coded“ --- to --- „coded“

## Coding VAG-Com (VCDS)

### Address 19 - CAN-Gateway needs to coded to Telephone

Vehicle	Index CAN Gateway	Coding
Caddy Eos Golf 5 Jetta Tiguan Touran (1T)	F K	Byte 3 - Bit 7
Caddy Eos Golf 5 Jetta Tiguan Touran (1T)	L	Byte 5 - Bit 2
Touareg (7L6)		Byte 4 - Bit 7
Passat (3C)	Q	Byte 6 - Bit 2
Passat (3C)		Byte 4 - Bit 2

## Control elements

### Wiper stalk

By pushing the sideways button about 3 seconds you will reach the DIS menu of the vehicle. Select „**KUFATEC FISCON**“ by pushing the **OK/Reset**-button. By using the sideways button you will choose the single options. By using the **OK/Reset**-button you will confirm the selection. In order to leave the menu select the option „**Back**“. You also can press the sideways button about 3 seconds.



### Multifunctional steering wheel

By pushing the **Menu** button you will reach the menu „**KUFATEC FISCON**“. By pushing the **OK**-button you will confirm the selections. By using the **Arrow**-buttons you will choose the single options. In order to leave the menu select the option „**Back**“. You also can press one of the arrow-buttons about 3 seconds.

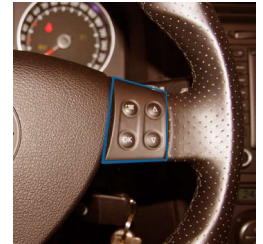

### VW Touareg GP

By pushing the **Menu** button you will reach the menu „**KUFATEC FISCON**“. By spinning as well as pushing the **Scroll-button** you will choose and confirm the single options. In order to leave the menu keep pressing the **Scroll-button** until the screen will switch one step back.



### Configuration possibilities:

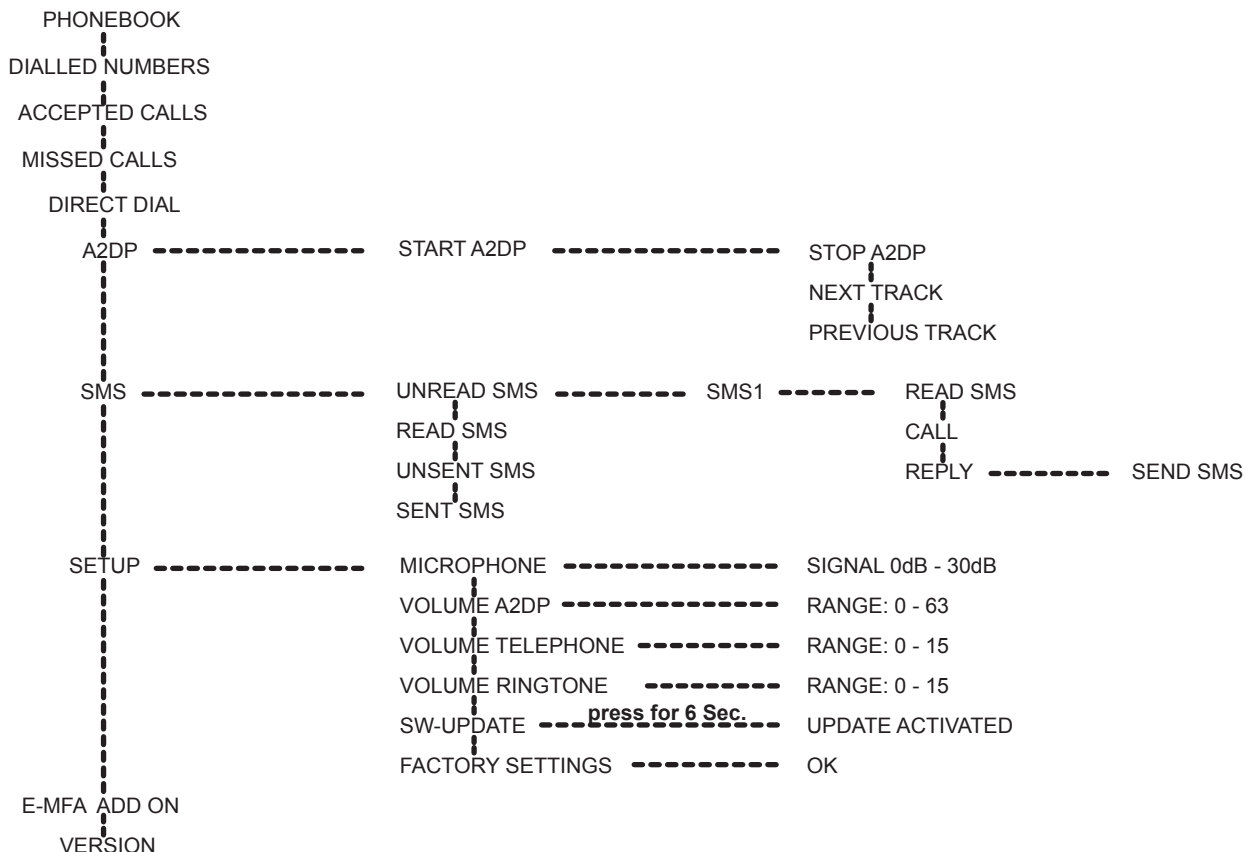

## Fiscon Menu

DIS	Description
PHONEBOOK	Access to the phonebook of the mobile phone. The phonebook feature is not supported by all mobile phones. Does your mobile phone support the phonebook feature you will have access to the phonebook. Phonebooks that have a large number of entries can take quite a long time to synchronise. Please avoid cancelations during synchronisation. The phonebook feature is limited to 1000 phonebook entries.
DIALLED NUMBERS	By choosing the menu <b>DIALLED NUMBERS</b> you are able to select these telephone numbers you dialled before (if supported from mobile phone).
ACCEPTED CALLS	By choosing the menu <b>ACCEPTED CALLS</b> you are able to select these telephone numbers you accepted before (if supported from mobile phone).
MISSED CALLS	By choosing the menu <b>MISSED CALLS</b> you are able to select these telephone numbers which tried to call you but you didn't accept (if supported from mobile phone).
DIRECT DIAL	You can use the multifunctional display and enter numbers by stalk or MFSW for dialling (0-9).
A2DP	By choosing the menu <b>START A2DP</b> the system will have access to the music files stored on the mobile phone (if supported from mobile phone). By using the MFSW as well as the wiper stalk you can select the single tracks (NEXT TRACK, PREVIOUS TRACK). By choosing the menu <b>STOP A2DP</b> the music playback will be stopped.
SMS	By choosing the menu <b>SMS</b> you will have access to READ, UNREAD, SENT as well as UNSEND short messages (if supported from mobile phone). You will have the possibility to READ SMS, to DIAL the number of the sender as well as to SEND ready made SMS.
SETUP	By choosing the menu <b>SETUP</b> you are able to set general settings of the hands free kit. - Microphone, Volume regarding to A2DP/ Ringtone/ Caller, SW-Updates, Factory settings.
E-MFA ADD ON	DIS - display of additional specific vehicle information - Oil temperatur, Boost, Remaining petrol capacity, Speed, Revolutions per minute
VERSION	Current interface information

### DTMF Dual-tone multi-frequency

Suitable for remote enquiry of an answering machine or processing of telephone computers.

While an activated phone conversation the menu **DTMF** can selected. Entering the numbers by using the steering wheel buttons.

## FISCON Setup through mobile phone



You are able to complete Interface settings by using your mobile phone.

**Condition** is that the mobile **transmits** the number to the head unit.

In case your mobile doesn't support that feature you need to use a phone which does.

### Setup

- Establish a Bluetooth connection between your telephone and the FISCON unit.
- Use the following setup - Code: **\*582#xxyy**
- Please see the table below for the values **xx** as well as **yy**.

Function	<b>xx</b>	<b>yy</b>	Example
Volume telephone	10	(01-15)	*582#1009
Volume ring tone	11	(01-15)	
Volume prompt	12	(01-15)	
Volume A2DP	13	(01-63)	*582#1346
Microphone adjustment	14	(01-15)	
Software update	20	25	
Factory settings	21	77	
Language setting	30	(00-07)	

### Language - 30

**00** = Vehicle language  
**04** = Italian

**01** = German  
**05** = French

**02** = Englisch  
**06** = Dutch

**03** = Spanisch  
**07** = Portuguese

- After entering the values please press the **Call** - button.

**NOTE:** The call will be answered with "The number does not exist" but the setup has been completed.

---

## Operating instruction

The following operations need to be done by the wiper control stalk as well as multifunctional steering wheel. How to operate please see page 4.

In case of FISCON version **Basic Plus** you are able to control the phone by using the original buttons (Touch screen) of the head unit VW **RNS 510, RCD 510, Columbus**.

Once the installation as well as the coding has been finished and the interface is connected the bluetooth pairing process between mobile phone and vehicle can be started.

## Pairing

1. Turn the ignition on.
2. Make sure the Bluetooth feature of your phone is turned on.
3. Start the pairing procedure on your mobile phone.
4. When prompted for a passkey, enter **1234** on your mobile phone.

**Note:** After Pairing the phonebook synchronisation will start. Phonebooks that have a large number of entries can take quite a long time to synchronise. Please avoid cancelations during synchronisation.

You will have the possibility to choose the menu **KUFATEC FISCON** by using the sideways button of the stalk as well as the multifunctional steering wheel.

In case of FISCON version **Basic Plus** you will have the phone menu on the screen of the head unit RNS 510. You will see the network provider's name as well as the coverage if supported from mobile phone.

### You may pair up to 5 different mobile phones.

In case you would like to pair the sixth mobile phone you need to restore the factory settings. In case of activating the factory settings all stored mobile phones get lost.

**Note:** At the time of activating the factory settings you need to cancel any Bluetooth connection to the FISCON system.

## Incoming calls

An incoming call will cause system operations as follows:

1. Mute activation - The ring tone of the mobile will be generated.
2. Display of the caller name (depends on mobile phone). In case the caller is not stored by name the number will be displayed in the cluster.

## Answer a call

Select the option **PICK UP/ REJECT** by using the stalk as well as the MFSW.

In case of FISCON version **Basic Plus** you are able to select by using the touch screen of the head unit VW RNS 510, RCD 510, Columbus.

Would you like to end a call select the option **TERMINATE**.

---

## Operating instruction

### Placing calls

Depending on your mobile phone you have got several possibilities to place a call.

Call register (if supported from mobile phone).

1. Select the menu **KUFATEC FISCON** by using the stalk as well as the MFSW.
2. Choose on of the following options:
  - DIALLED NUMBERS
  - ACCEPTED CALLS
  - MISSED CALLS ... and confirm the selection.
3. Select an entry - the call will be placed by confirming.

In case of FISCON version **Basic Plus** you are able to select by using the touch screen symbol **CALLS**:

- MISSED CALLS
- DIALLED
- ACCEPTED

### Phonebook

**Note:** The phonebook feature is not supported by all mobile phones. Does your mobile phone support the phonebook feature you will have access to the phonebook.

The phonebook feature is limited to **1000 phonebook entries**.

(Subentries included)

**Note:** Phonebooks that have a large number of entries can take quite a long time to synchronise. Please avoid cancelations during synchronisation.

1. Select the menu **KUFATEC FISCON** by using the stalk as well as the MFSW.
2. Choose the menu **PHONEBOOK**.
3. Select an entry - the call will be placed by confirming.

**Note:** By pressing the **Arrow** - buttons about 3 seconds you will get to the next initial letter of the phonebook.

In case of FISCON version **Basic Plus** you are able to select by using the touch screen symbol **PHONEBOOK**.

---

## Operating instruction

### Direct dial

1. Select the menu **KUFATEC FISCON** by using the stalk as well as the MFSW.
2. Choose the menu **DIRECT DIAL**.
3. Enter the number by using the stalk as well as the MFSW - the call will be placed by confirming.

### Dial plate (Only version Basic Plus)

1. Select the Touch screen symbol **DIAL PLATE**.
2. Enter the number and select the **DIAL** button.

### A2DP Audiostreaming

**Note:** The A2DP feature is not supported by all mobile phones. Does your mobile phone support the A2DP feature you will have access to the music files stored on your mobile.

1. Select the menu **KUFATEC FISCON** by using the stalk as well as the MFSW.
2. Choose the menu **A2DP** → **START A2DP**.
3. By using the options **NEXT TRACK/ PREVIOUS TRACK** you can choose the single files.
4. By choosing the menu **STOP A2DP** the music playback will be stopped.

### SMS short messages

1. Select the menu **KUFATEC FISCON** by using the stalk as well as the MFSW.
2. Choose the menu **SMS**.
3. Choose on of the following options:
  - UNREAD
  - READ
  - UNSEND
  - SENT ... and confirm the selection.
4. Select one of the listed short messages (SMS1, SMS2...)
5. Choose on of the following options:
  - READ SMS
  - CALL
  - REPLY ... and confirm the selection.

In case you will select the option REPLY you will have a number of ready made short messages.

## Operating instruction

### SETUP

1. Select the menu **KUFATEC FISCON** by using the stalk as well as the MFSW.
2. Choose the menu **SETUP**.
3. Choose on of the following options:
  - MICROPHONE (Signal boost 0dB - 30dB)
  - VOLUME A2DP (Value 0 - 63)
  - VOLUME TELEPHONE (Value 0 - 15)
  - VOLUME RINGTONE (Value 0 - 15)
  - SW UPDATE
  - FACTORY SETTINGS ... and confirm the selection.

**NOTE SW UPDATE:** Step to the menu SW UPDATE. For activating the update the button has to be pressed for at least 6 seconds.

### E-MFA Add on

1. Select the menu **KUFATEC FISCON** by using the stalk as well as the MFSW.
2. Choose the menu **E-MFA ADD ON**.
3. DIS - display of the following specific vehicle information:
  - Boost pressure in bar (depends on vehicle)
  - Oil temperature in°C/ F
  - Water temperature in°C/ F
  - Remaining petrol capacity in l
  - Speed in km/h - m/h
  - Revolutions per minute
  - Battery voltage in V

By using the buttons of the multifunctional steering wheel as well as the wiper stalk you will switch between:

- RPM - Petrol capacity
- Boost pressure - Battery voltage

The DIS Add-On will display changes of the scale unit (°C/F as well as Km/miles) automatically.

**Note:** Regarding to the Boost you are able to switch between mode 1 and mode 2 (depending on the engine type). Therefore you need to press the arrow-buttons after selecting the menu E-MFA. In some cases the display of the boost is not possible.

### Version

1. Select the menu **KUFATEC FISCON** by using the stalk as well as the MFSW.
2. Choose the menu **VERSION**.
3. Display of current interface information.

## Interface - Diagnostic

By using the original VW diagnostic software **VAS** specific **information** can be checked as well as a **RESET** of the hands free system can be completed.

In order to complete a **RESET** you need to proceed as follows:

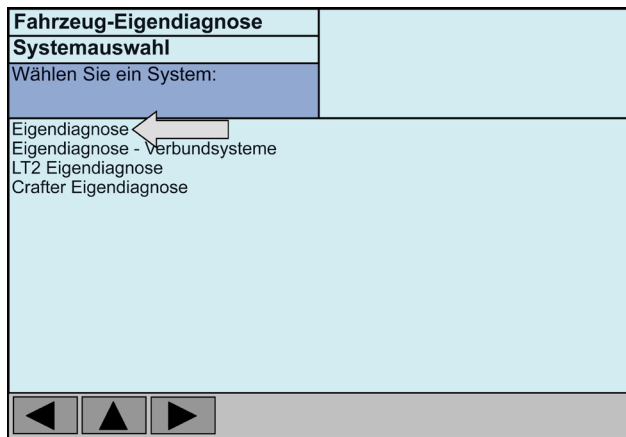

Vehicle self diagnostic

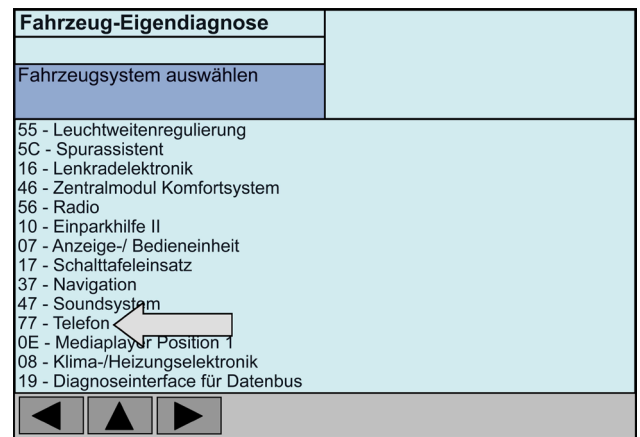

Adresse 77 - Telephone

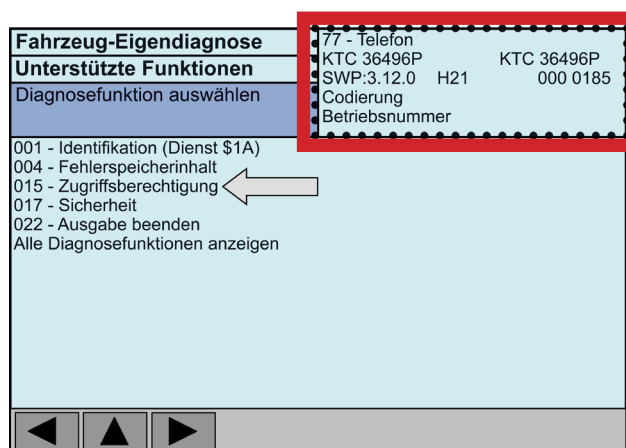

015 - Security access

Interface information

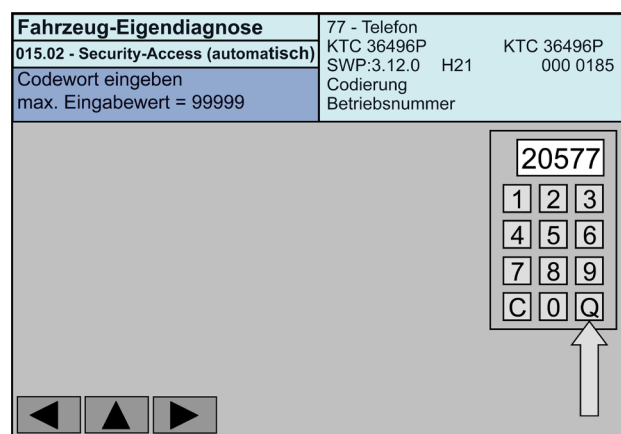

Value 20577 - confirm

**Value 20577 --- Q (quit) --- RESET completed**

**Note:** After completing a RESET the bluetooth connection to the hands free will be canceled.

---

## FAQ

I do not get any connection to the FISCON hands free!

- A number of 5 different mobile phones have already been connected to the FISCON hands free. In order to connect another mobile phone the factory settings has to be activated.

Why does not pop up the phonebook on the screen of the head unit RNS 510?

- The phonebook feature is not supported by all mobile phones.
- Phonebooks that have a large number of entries can take quite a long time to synchronise.

I don't have any access to the phone menus like „Dialed numbers“, „Accepted calls“, „Missed calls“.

- These features are not supported by all mobile phones.

The FISCON system won't be accepted by the vehicle.

- In case a non-Kufatec video interface is fitted we are not able to guaranty the absolute operation of the FISCON system.
- Any mobile phone preparations which are communicating with the CAN Bus system of the vehicle have to be removed!
- The system has to be coded specific to the radio as well as vehicle.

I'm not able to operate the hands free kit by using the buttons of the head unit RNS 510.

- Operation by using the original buttons of the RNS 510 head unit only available with FISCON version „Basic Plus“.

Why does the E-MFA Add on not appear?

- The E-MFA Add on is only for vehicles with red DIS. It is not suitable for the white DIS.

Why does the mute function cut of continuously?

- The vehicle is already equipped with an hands free kit. This hands free kit has to be removed.

The factory fitted telephone interface on my VW T5 (facelift) 2010 model year is not located underneath the passenger seat.

- The telephone is located behind the glove box in case of VW T5 (Facelift) 2010.